

ERSTER NACHTRAG

ZUM

LEHRBUCH

DER

AUFBEREITUNGSKUNDE

VON

P. RITTER VON RITTINGER

ATLAS

VII TAFELN

1913. 1375

BERLIN
VERLAG VON ERNST & KORN
(GROPIUS'SCHE BUCH- UND KUNSTHANDLUNG)
1870.



Verzeichnifs der Figurentafeln.

Tafel XXXV	Figur 281 bis 287 ^{c-d} .
- XXXVI	- 287 - 289
- XXXVII	- 290
- XXXVIII	- 291 - 294
- XXXIX	- 295 - 298
- XXXX	- 299 - 301
- XXXXI	- 302 - 306





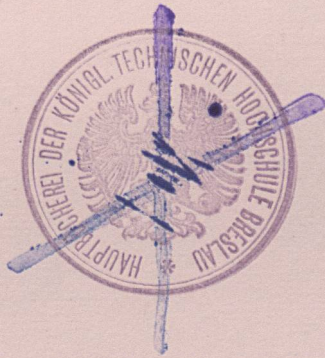

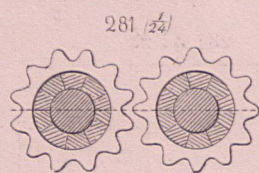

281 (1/4)

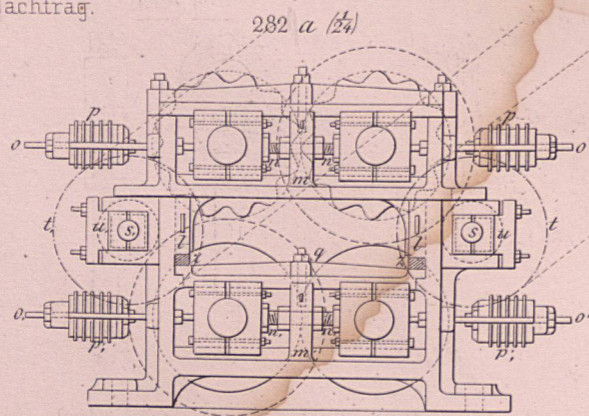

282 a (1/4)

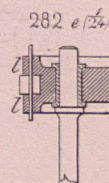

282 e (1/4)

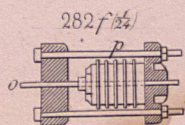

282 f (1/4)

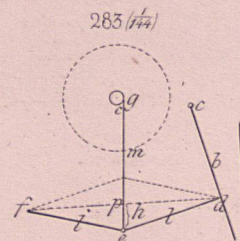

283 (1/4)

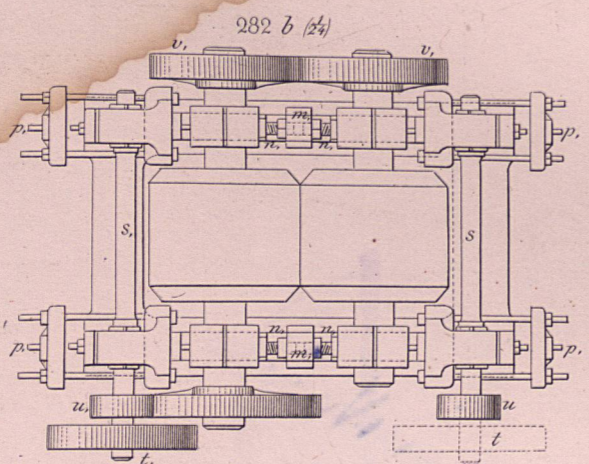

282 b (1/4)

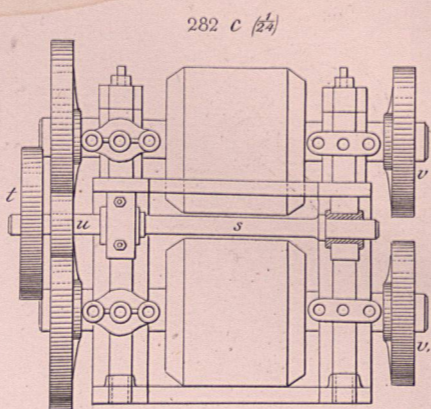

282 c (1/4)

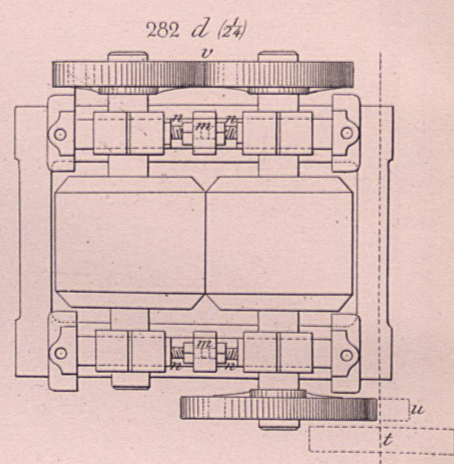

282 d (1/4)

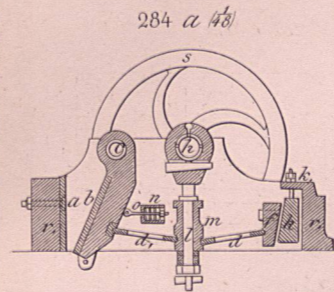

284 a (1/8)

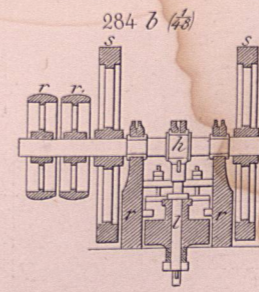

284 b (1/8)

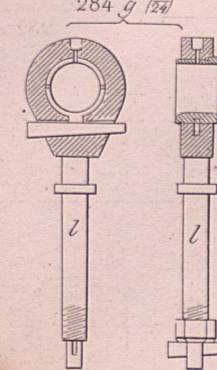

284 g (1/4)

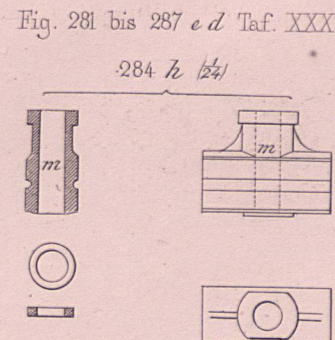

284 h (1/4)

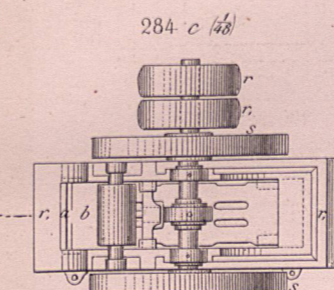

284 c (1/8)

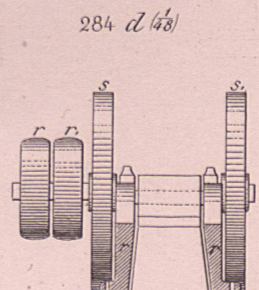

284 d (1/8)

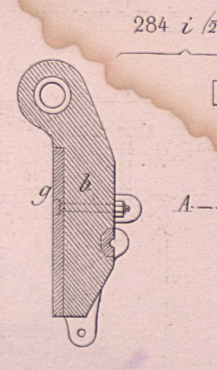

284 i (1/4)

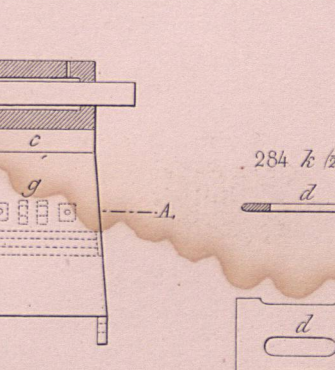

284 k (1/4)

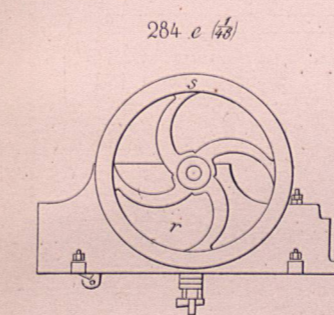

284 e (1/8)

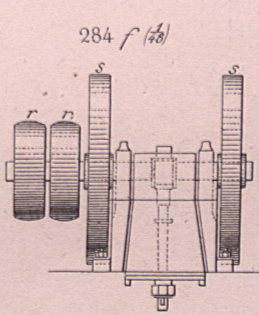

284 f (1/8)

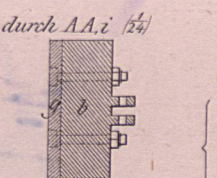

durch A.A.i (1/4)

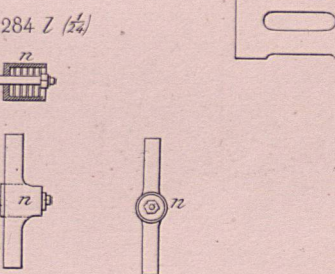

284 l (1/4)

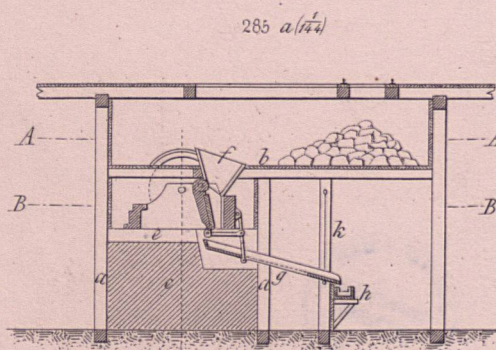

285 a (1/4)

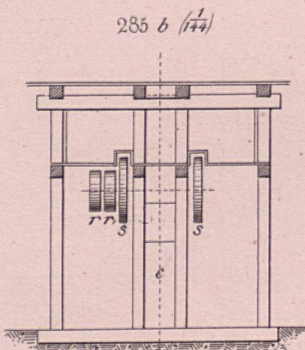

285 b (1/4)

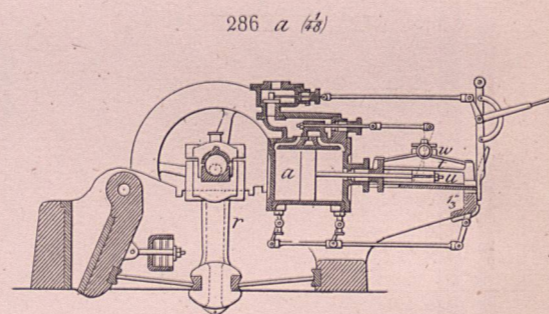

286 a (1/8)

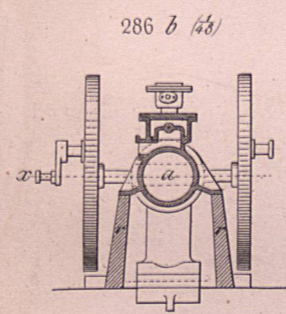

286 b (1/8)

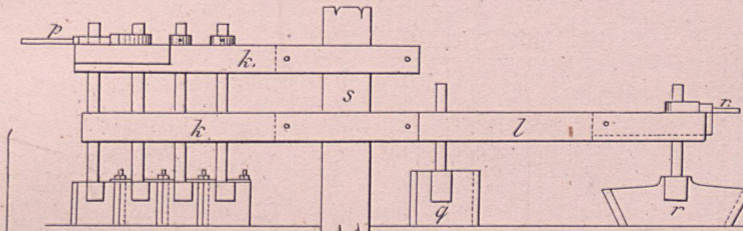

287 c (1/8)

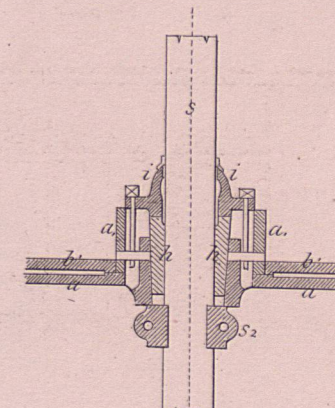

287 d (1/4)

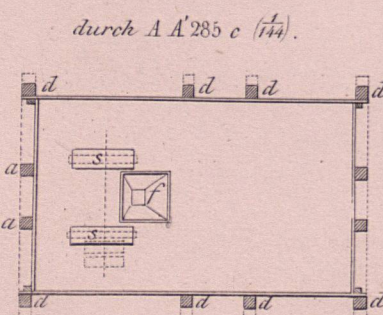

durch A A' 285 c (1/4)

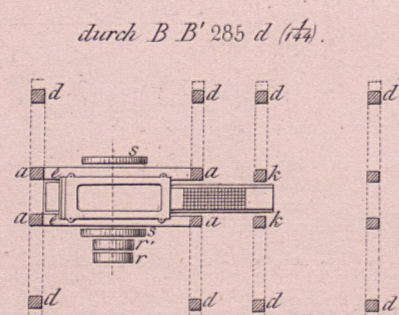

durch B B' 285 d (1/4)

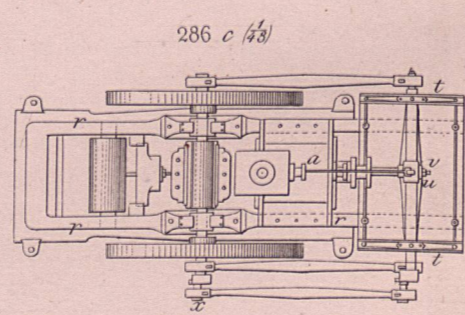

286 c (1/8)

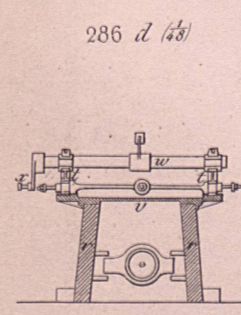

286 d (1/8)

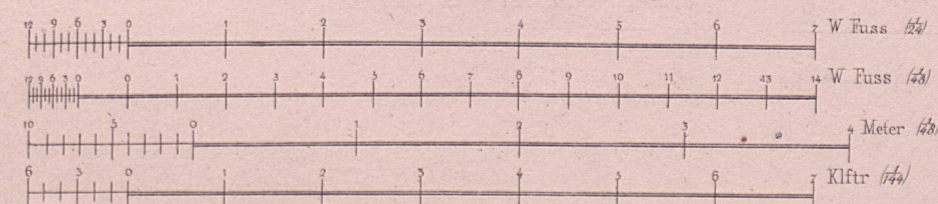
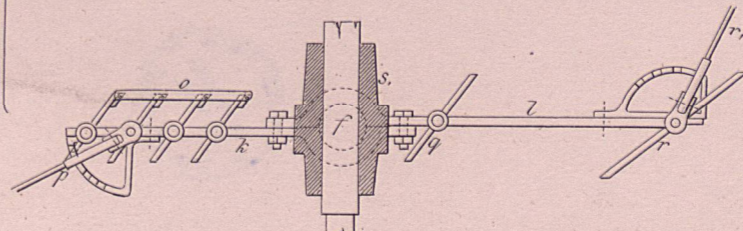

Ritter gest.





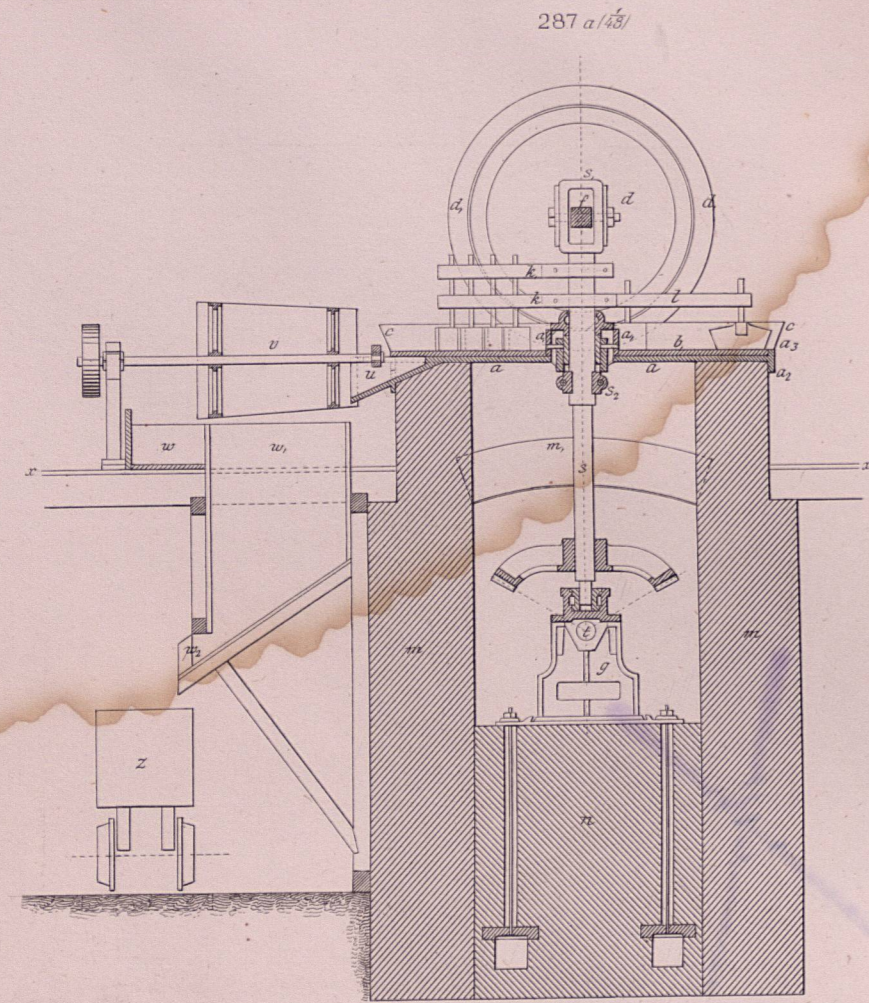

287 a / 143/

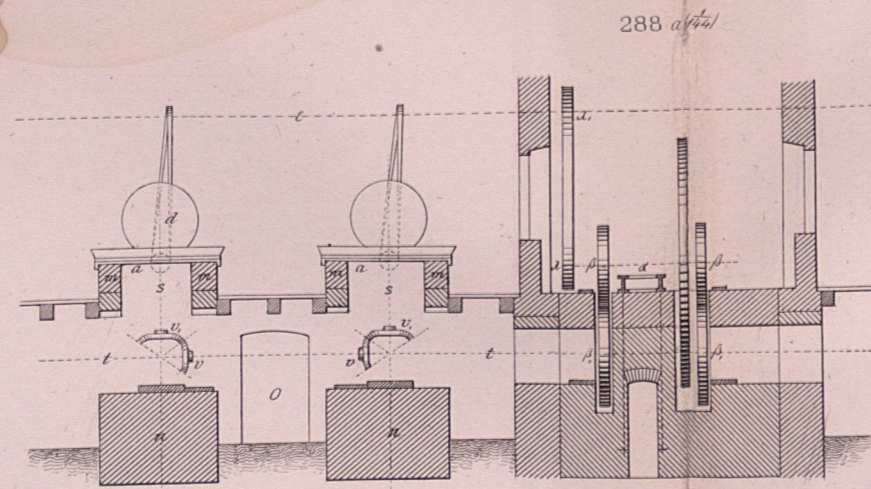

288 a / 144/

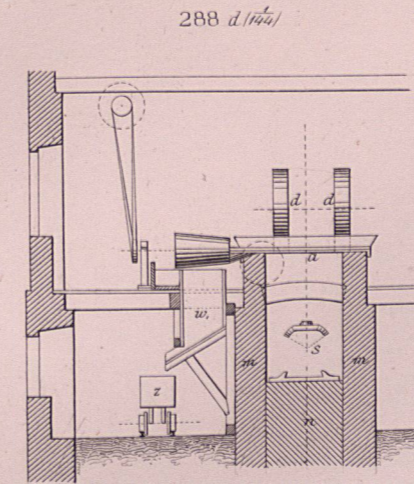

288 d / 145/

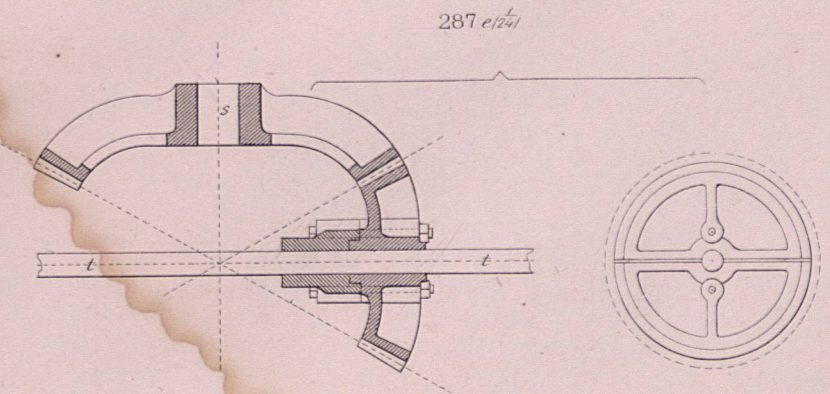

287 e / 146/

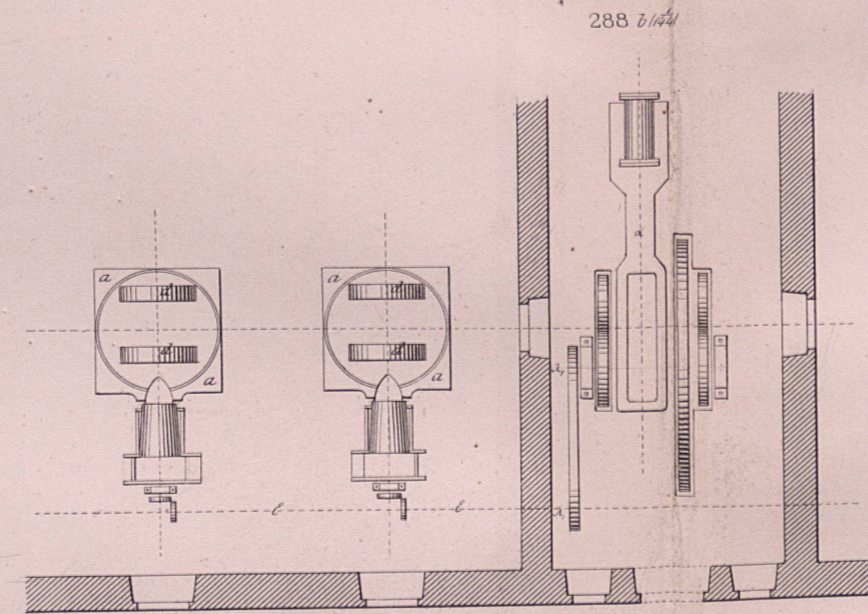

288 b / 147/

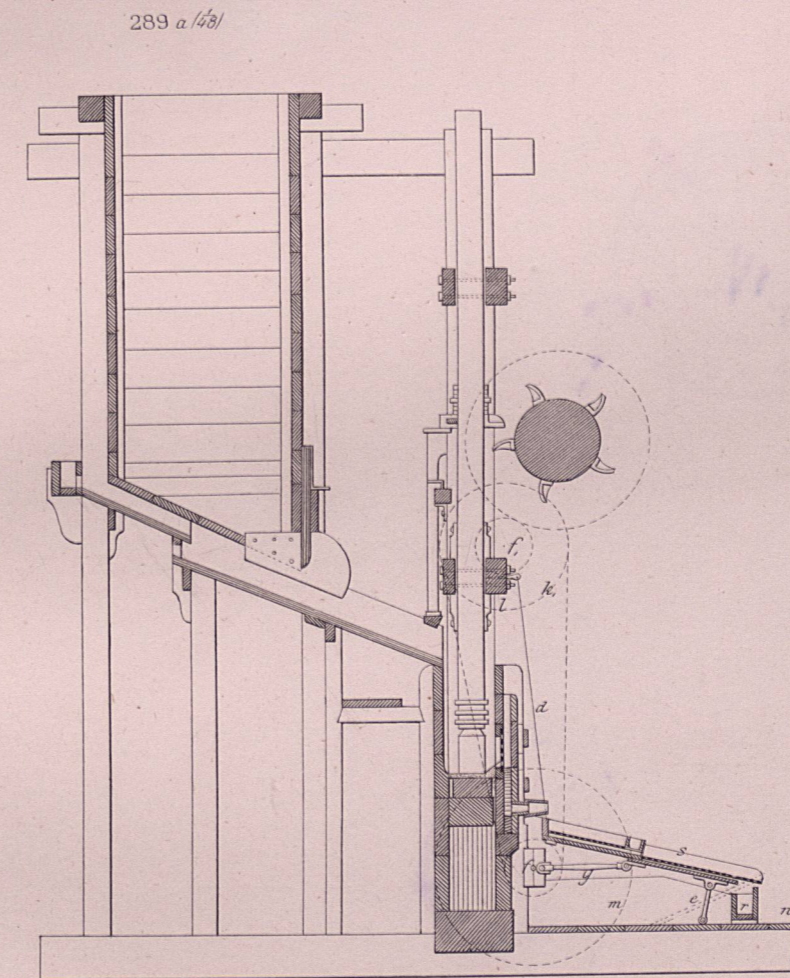

289 a / 148/

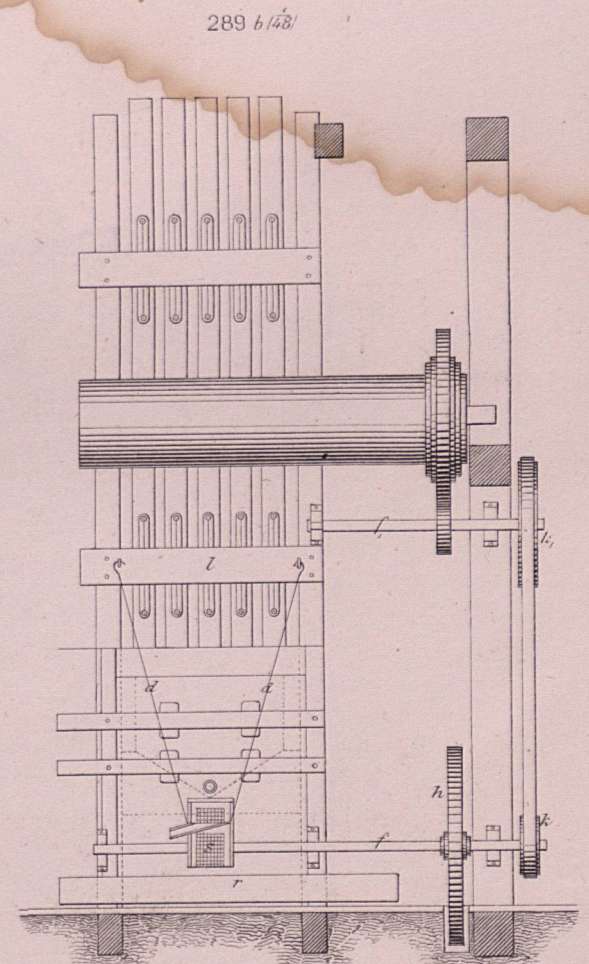

289 b / 149/

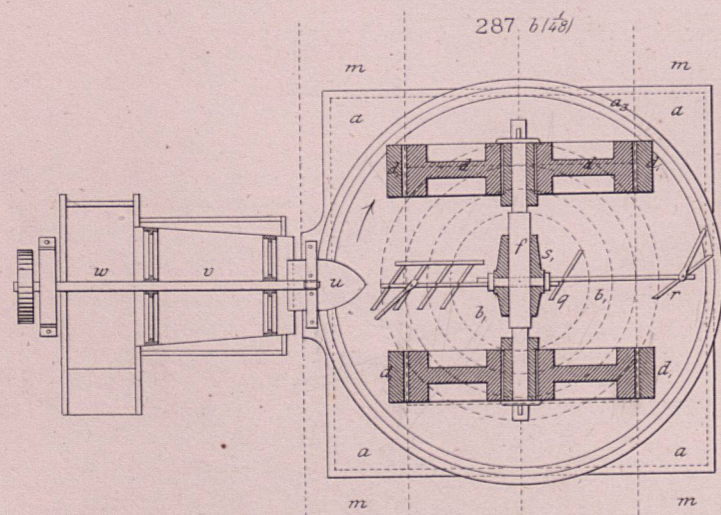

287 b / 150/

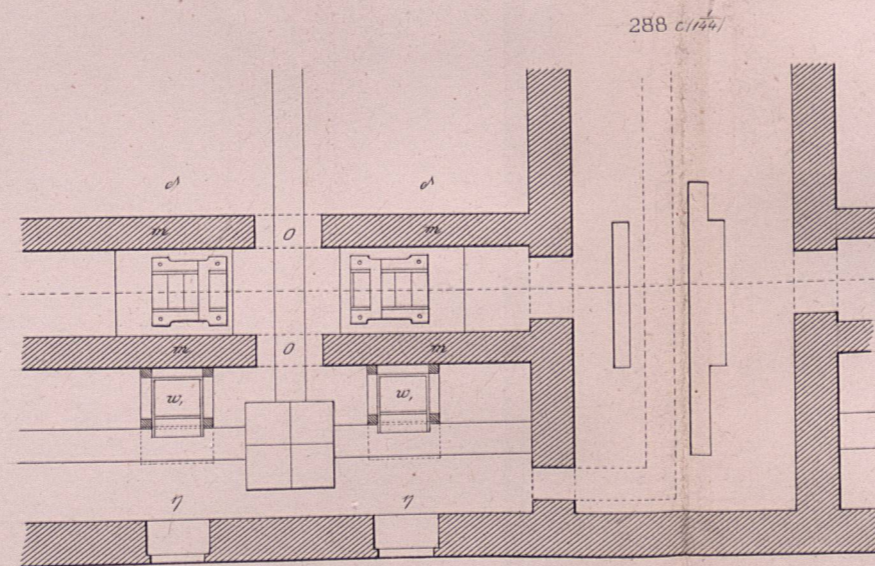

288 c / 151/

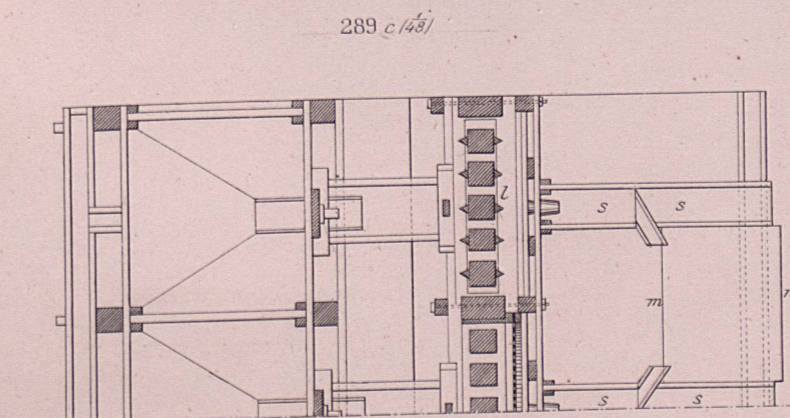

289 c / 152/

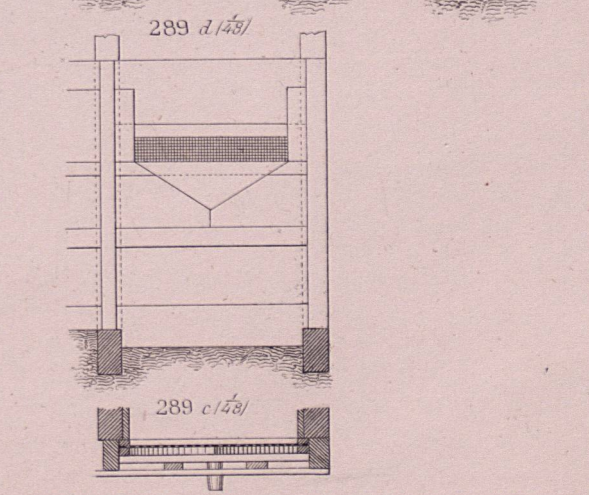

289 d / 153/

289 c / 153/

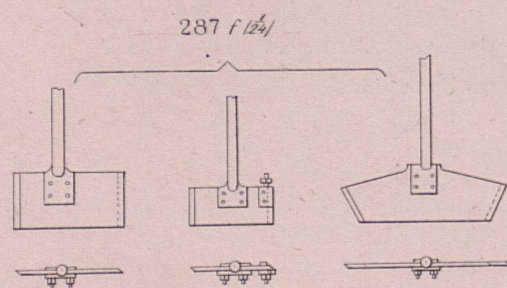

287 f / 154/





